

Article number: 604145029115

Description: Timing belt pulley with hub
HTD 29 14M 115

Measures

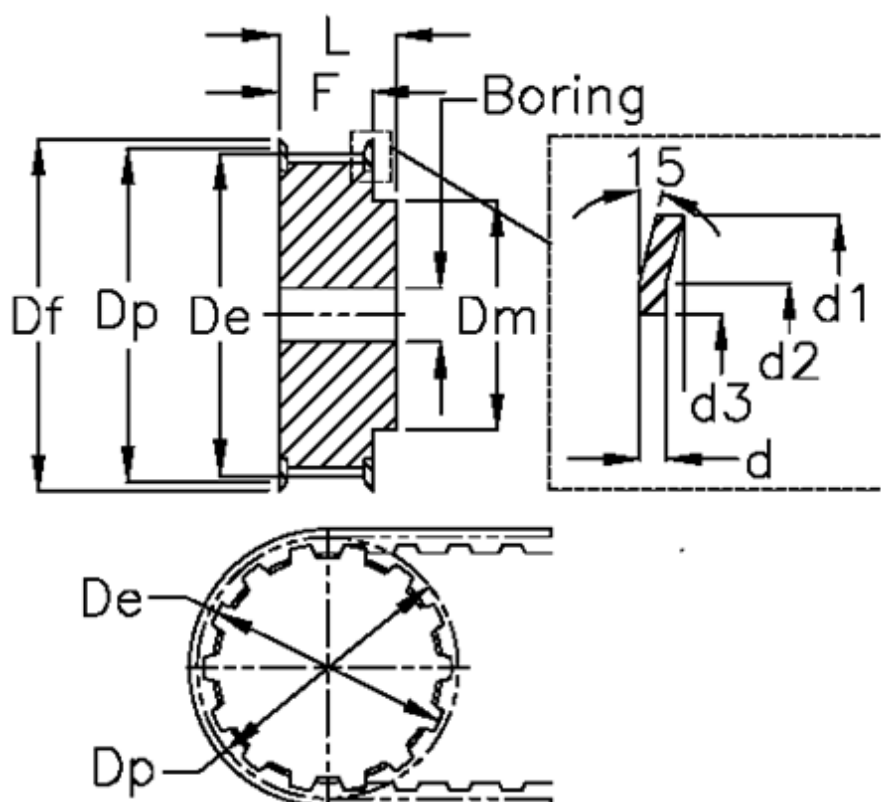

Bore = 32	Dp	= 129.23
d = 2.5	F	= 133
d1 = 138	Flange type	= F43
d2 = 132	L	= 148
d3 = 121	Tooth number	= 29
De = 126.57	Type	= 14M
Df = 138	Weight	= 10.2
Dm = 100	Width	= 115